

HYDRAULIC EASY PULLER MODEL:PME600

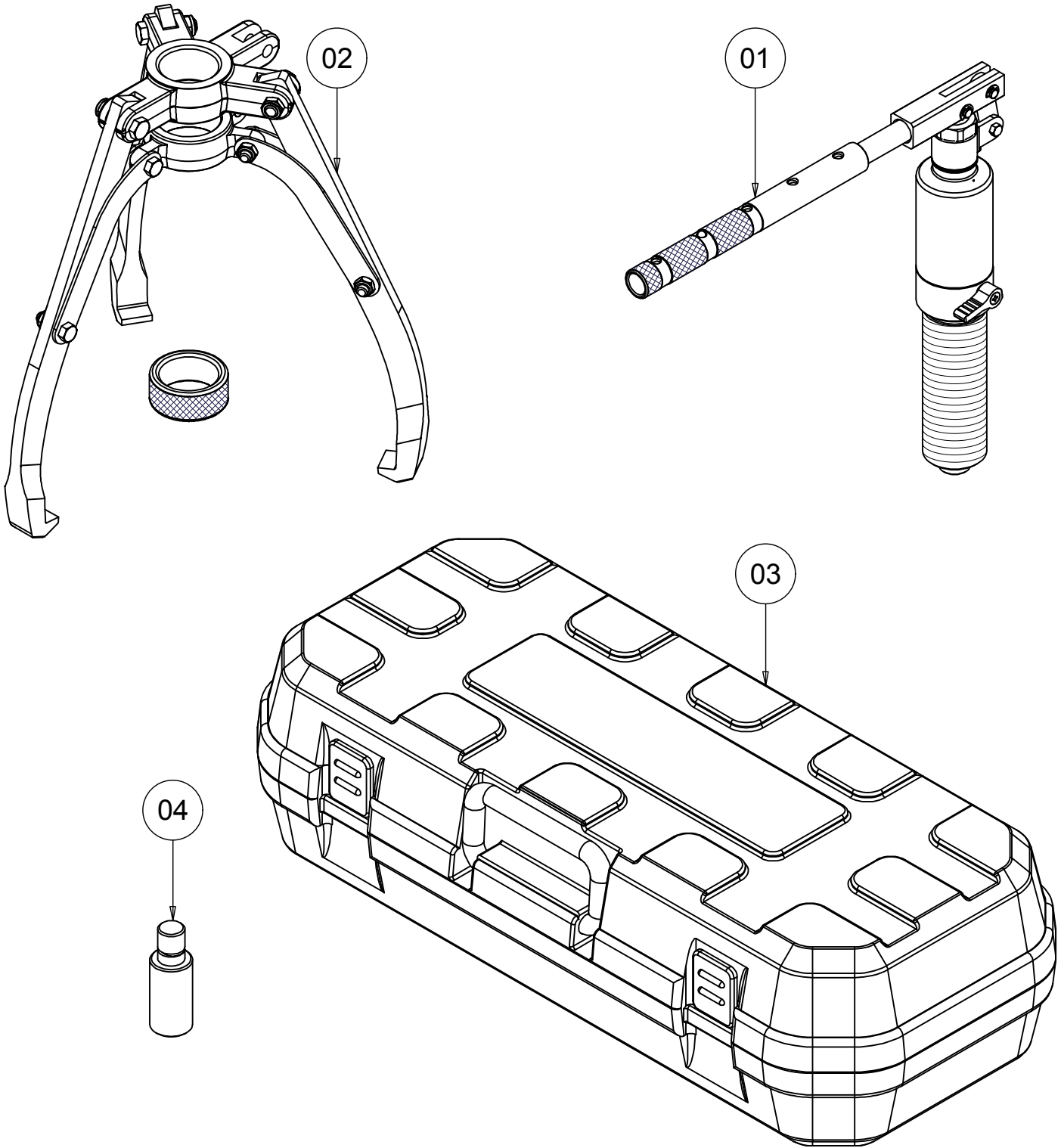

REF NO.	PARTS NO.	DESCRIPTION	QTY
01	PM06R	Puller Body	1
02	JAE06T	Jaw Assembly	1
03	G0860	Blow Molded Case	1
04	B1128	Extension Bar	2