

SEPARATE HYDRAULIC EASY PULLER MODEL:PRE800

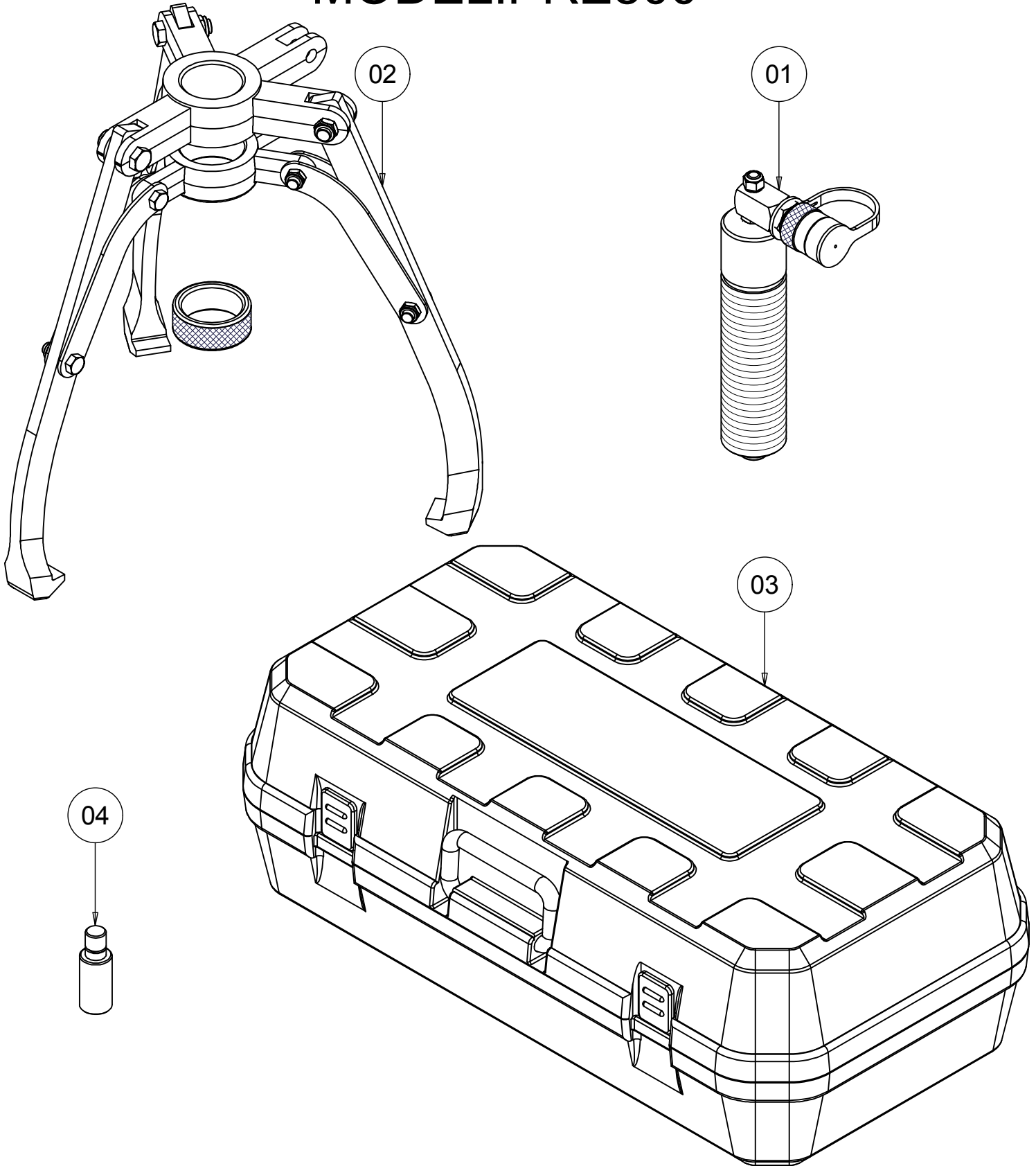

REF NO.	PARTS NO.	DESCRIPTION	QTY
01	PR08R	Puller Body	1
02	JAE08T	Jaw Assembly	1
03	G0861	Blow Molded Case	1
04	B1128	Extension Bar	3